DB Cargo Report – Preparing the Sion-Sierre Test Runs

Author(s)	Jens Nolte (I-NAT-SR40-PMO-PLP) SR40 ATO Team
Confidentiality	Public
Status	Approved
Version	V1.0
Last amended on	7. January 2021
Last amended by	
Copyright	This document is protected by copyright. Specific authorisation must be obtained in advance before the document is used for any commercial purpose whatsoever.
Filed under	Publication of this document and related reference documents: https://www.smartrail40.ch .
Original language	German
	In the event of inconsistencies between the language versions, the original language version shall take precedence.

CONTENTS

List of Figures	3
List of Tables	3
Glossary	4
1. Management summary	5
1.1. Summary of the results of the validation test results	6
1.2. More wide-reaching findings	6
2. Introduction	6
2.1. The objectives of the preparations for the Sion-Sierre pilot	7
2.2. Generic system architecture of ATO GoA2	7
2.3. Test environment	8
2.4. Test organisation	9
2.5. Raw data recorded	11
2.6. Test cases	11
3. Commissioning	12
4. Observations	13
4.1. Preparing the line for the DB Cargo test runs	13
4.2. Basic driving performance	14
4.3. Further consideration of driving performance / additional parameters	16
4.4. Outlook	18
5. Conclusion	19
6. Reference documents	19
Annex 1 – Acceleration measurements	20

List of Figures

Figure 1 The generic system architecture.....	7
Figure 2 The test route	8
Figure 3 Test organisation and general overview of the system	9
Figure 4 The data which was collected.....	11
Figure 5 Time difference from the scheduled arrival time	14
Figure 6 Analysis of the accuracy of the stopping procedures	15
Figure 7 Driving close to the braking curve.....	16
Figure 8 Comparison of energy consumption, driving profile and stopping accuracy	17
Figure 9 Example of a smoothed measurement curve.....	20
Figure 10 Transverse direction	21
Figure 11 Longitudinal direction.....	21
Figure 12 Comparison of jerk change in transverse and longitudinal directions.....	21

List of Tables

Table 1 Achievement of the phase objectives.....	6
Table 2 Stations and departure times	8
Table 3 Details of the test environment	9
Table 4 Test team roles.....	11

Glossary

ARCC	Automated Rail Cargo Consortium (Shift2Rail Program)
ATO Disengaging (DE)	An ATO OBU operating mode, equivalent to "transition from active to inactive state". From ATO
ATO Engaged (EG)	An ATO OBU operating mode, equivalent to "ATO active"
ATO OBU	Automatic Train Operation – On Board Unit (in RCA: ATO-AV)
ATO Ready (RE)	An ATO OBU operating mode, equivalent to "ATO not active, but can be activated"
ATO-TS	Automatic Train Operation – Trackside (in RCA: ATO-AT)
DCS	Data Collection System (central SBB system from which the energy data was obtained)
DDS	Data Distribution Service (vehicle control technology data storage)
DMI	Driver Machine Interface
EMS	Energy Meter System, records the vehicle's total energy consumption.
EoA	End of Movement Authority – End of the ETCS movement authority
ETCS L2 FS	European Train Control System Level 2 Full Supervision
Journey Profile	A set of timetable, route and other operational data describing a journey to be made by an automatically operated train
Passing Point	A point along the route which, using ATO, is passed at a specifically defined time.
RBC	Radio Block Centre
RCS	Rail Control System (SBB's scheduling system)
RU	Railway undertaking
Segment Profile	A set of infrastructure data required for conducting automated movements.
Shift2Rail	The EU's Railway Innovation Initiative
SS125	Functional system requirements for an interoperable "ATO over ETCS" system, restricted to GoA1 (C-DAS) and GoA2 (excl. GoA3 and GoA4).
SS126	ATO-OB / ATO-TS Interface (FFFIS)
SS130	ETCS-OB / ATO-OB Interface (FFFIS)
SS139	ATO-OB / Train Interface (FFFIS)
Stopping Point	A stopping point along the route at which ATO stops at a specifically defined time.
TCMS	Train Control and Management System, vehicle control technology
TMS	Traffic Management System (scheduling system; at SBB this is RCS)
TSI	Technical Specifications for Interoperability

1. Management summary

As part of the EU rail innovation programme Shift2Rail, the 'Automated Rail Cargo Consortium' (ARCC) carried out the 'ARCC ATO GoA2 Freight Demonstrator' pilot; DB Cargo was in overall charge of the pilot. A memorandum of understanding was concluded between smartrail 4.0 and DB Cargo. This allowed DB Cargo to carry out test runs on the ETCS L2 Lausanne-Villeneuve line using the ATO Trackside developed by smartrail 4.0. In return, SBB was able to be actively involved in the lessons learned about automated freight train operation.

Because the timetable for the test runs was postponed and because this conflicted with planned construction work between Lausanne and Villeneuve, an alternative had to be sought. The ETCS L2 Sion-Sierre line was identified as the most suitable. Since no ATO project plans existed for this line, the relevant segment data had to be created for the ATO Trackside. Furthermore, there were no empirical values from the SBB test runs for this section of line either, so validation test runs were carried out with the FLIRT and the ATO OBU used for ATO2Basic. This was done with the aim of validating the newly created segment profiles and of ensuring that the line could be used for DB Cargo's test programme.

At the same time, the validation runs allowed us to investigate and ensure that the ATO OBU functioned correctly irrespective of the line on which it was used. An extensive volume of data material was also collected during these SBB validation test runs. This material was compared with the data from the ATO2Basic test runs and the results checked against each other.

The following test run aims were achieved in full.

- The Sion-Sierre line is suitable for DB Cargo test runs; the ATO project plans (segment profiles) have been validated.
- It was confirmed that ATO GoA2 operations with an ATO OBU and the ATO TS in accordance with the draft TSI 2022 can be carried out irrespective of whichever line is used.
- Important findings from the smartrail 4.0 live tests as part of ATO2Basic were confirmed (see Reference 2) and additional data material was collected for possible subsequent analysis.

DB Cargo carried out test runs on the line from 01.09.2020 to 10.12.2020. The main findings of ATO2Basic were corroborated. In addition, an extensive volume of data material was collected which can be used for possible subsequent analyses.

1.1. Summary of the results of the validation test results

Objective		Remarks
Both the line and the ATO project plans (segment profiles) are suitable for DB Cargo trials	✓	
ATO operation in accordance with the TSI 2022 draft standards is possible irrespective of whichever line is used	✓	The ATO runs were carried out using the newly created segment profiles without the ATO OBU needing to be re-calibrated
Confirmation of the findings from the test runs on the Lausanne-Villeneuve line	✓	The main findings from ATO2Basic were corroborated.

Table 1 Achievement of the phase objectives

1.2. More wide-reaching findings

A comparison of the data recorded on the test runs on the Lausanne-Villeneuve and Sion-Sierre lines shows that the essential driving characteristics were very similar on both lines; it can therefore be confirmed that ATO, in accordance with the future TSI standard, is possible irrespective of whichever line is used:

- Precise arrival within a few seconds
- Precise stopping
- Precise driving at the system limits / along the braking curve
- Energy-saving driving performance

2. Introduction

The 'ATO GoA2 Freight Demonstrator' is a project forming part of Shift2Rail, which is being carried out by the Automated Rail Cargo Consortium (ARCC) under the overall management of DB Cargo (see Reference 3). In addition to DB Cargo, the members of the consortium are the vehicle manufacturer Bombardier Transportation, the ETCS OBU and ATO OBU supplier Siemens, and the ATO OBU suppliers Alstom, Hitachi and AZD Praha. As part of this project, DB Cargo is conducting ATO GoA2 freight traffic test runs in cooperation with smartrail 4.0.

SR40 provided the necessary journey and segment profiles and a mobile radio router. Support services were provided during the approval process and while assisting with the test runs.

This document describes the measures taken to ensure that the line was suitable for carrying out DB Cargo's test runs.

2.1. The objectives of the preparations for the Sion-Sierre pilot

2.1.1. Main objectives

- Verification of the ATO-TS segment profiles for the Sion-Sierre section of line
- Confirmation of the suitability of the Sion-Sierre line for the DB Cargo test runs

2.1.2. Secondary objectives (findings in addition to those from ATO2Basic)

- Confirmation that the draft TSI 2022 standards applied irrespective of the whichever line was used
- Corroboration of the ATO driving performance findings from ATO2Basic using the additional data recorded

2.2. Generic system architecture of ATO GoA2

The following figure illustrates the generic system architecture at GoA2 level; it also describes the most important function blocks, including the way ATO OBU is embedded within the peripheral systems.

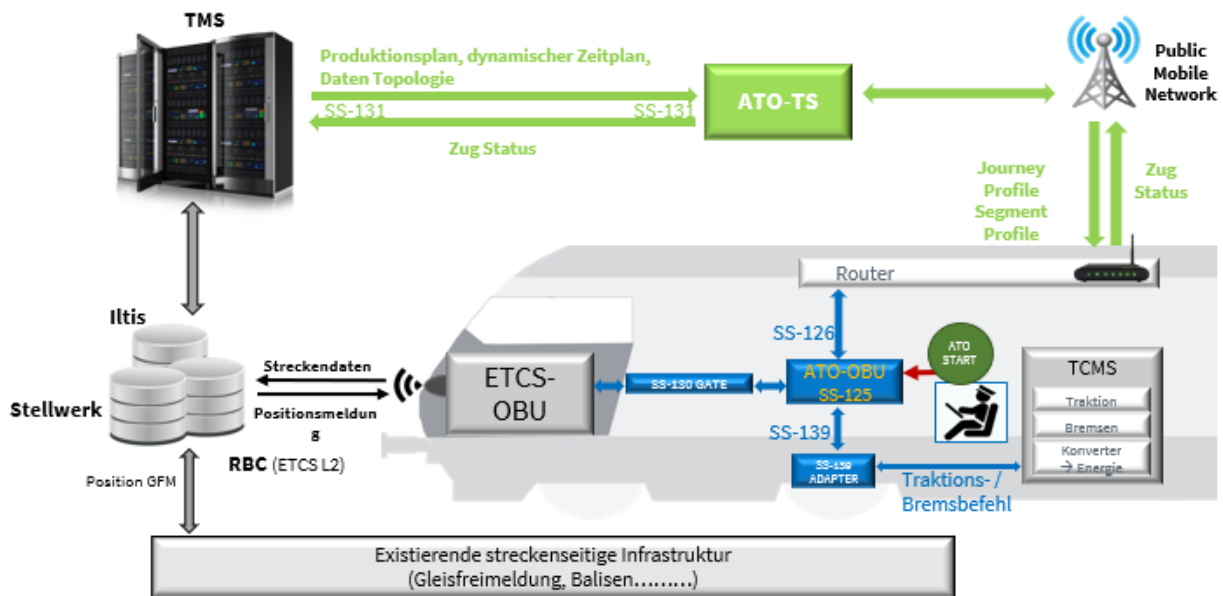

Figure 1 The generic system architecture

2.3. Test environment

The trials (all test cases) took place on the twenty-kilometre long Ardon-Châteauneuf-Sion-Sierre line (ETCS L2 FS). The Ardon turning point is not located in the area covered by ETCS L2. The first station which can be approached under ATO operation is Châteauneuf-Conthey.



Figure 2 The test route

According to the SBB timetable, standard service journey times measured from the departure station are as follows:

Stn. no.	Stop/station	Arrival minute, outward journey	Departure minute, outward journey	Arrival minute, return journey	Departure minute, return journey
1	(Châteauneuf-Conthey)		00	16	
2	Sion	06	07	12	13
3	St-Léonard	10	10	05	06
4	(Granges-Lens)	No scheduled stop for passenger services			
5	(Pramont)	No scheduled stop for passenger services			
6	Sierre	17			00

Table 2 Stations and departure times

Details of the infrastructure, of the vehicle (including its equipment) and of the current version of the standard are listed in the table below:

Title	Description
Test route	Châteauneuf-Sion-Sierre (20 km)
Stops/stations	6 (4 of which are regular-service passenger stops)
Test vehicle	Stadler FLIRT (4-car S-Bahn multiple unit) 523 028
ATO OBU	Functional model based on S2R Pilot Line supplied by Siemens in accordance with draft TSI 2022 standard
ETCS OBU	Baseline 2.3.0.d supplied by Siemens with SS130 adapter
Infrastructure	ETCS L2 FS supplied by Siemens (without any adaptations for ATO tests) Baseline 2.3.0.d
Draft standards	SS125 Version 0.1.0 / as at 04.05.2018 SS126 Version 0.0.16 / as at 07.05.2018 SS130 Version 0.1.0 / as at 04.05.2018 SS139 Version 0.0.9 / as at 01.02.2019

Table 3 Details of the test environment

2.4. Test organisation

A test organisation was established to carry out the planned trials and record the measurement results. A team of several people was involved in this process.

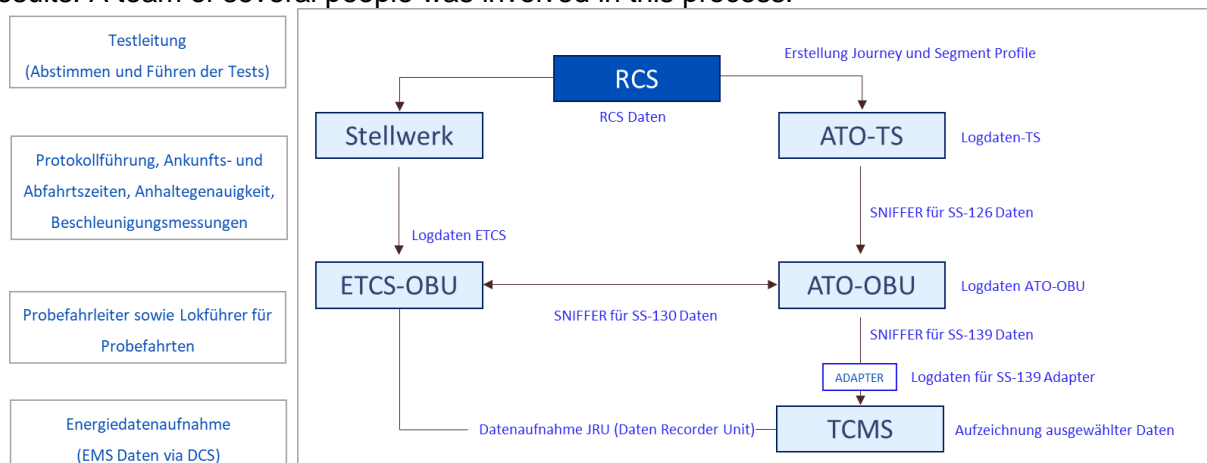

Figure 3 Test organisation and general overview of the system

This figure shows the various responsibilities in relation to the test system. In each case, the relevant data is shown at the corresponding interfaces. For example, the sniffer at the subsets is a

device for recording the respective data transmitted; each recording device was supervised by a specified team member.

Responsibility for each task was clearly assigned to an individual team member. Certain tasks were carried out by non-permanent team members who were not involved full-time in the test runs. These are described as "Various" in the list of responsibilities.

Responsibility	Person responsible	Organisation	Remarks
Record keeping	Jens Nolte	SR40	Test cases conducted, special occurrences (weather, etc.)
Noting arrival / departure times	Jens Nolte	SR40	Using a GPS watch
ATO OBU log data	Jens Nolte	SR40	Analysis only possible by the supplier (Siemens)
Creating the journey and segment profiles	Daniel Minder	SBB IT ATO-TS	Data from TMS to ATO-TS
ATO-TS log data	Daniel Minder	SBB IT ATO-TS	
SS-139 data	Michael Matthias	SBB-P	Sniffer between ATO OBU and TCMS
SS-126 data	Michael Matthias	SBB-P	Sniffer between ATO OBU and ATO-TS
SS-130 data	Michael Matthias	SBB-P	Sniffer between ATO OBU and ETCS
SS139 adapter log data	Michael Matthias	SBB-P	The adapter's log files
JRU data	Franziska Wanner	SBB-P	TELOC® data recorder
Control system parameters	Franziska Wanner	SBB-P	TOP1131® Recording of selected control technology data
Energy data	various	SBB-I-EN	EMS data via DCS
RCS data	various	SBB IT, SR40	
Locomotive personnel for test runs (LFP)	various	SBB-P	
Test run manager (PFL)	various	SBB-P	Contact with the traffic controller in the operations centre
Vehicle conversion	Michael Matthias Franziska Wanner	SBB-P	
Test director	Franziska Wanner	SBB-P	Coordination and in overall charge of the tests with all persons involved
ETCS log data	Franziska Wanner	SBB-P	(for part)
DDS	Franziska Wanner	SBB-P	Occurrence data control technology (for part)
Video recordings	Franziska Wanner	SBB-P	Using GoPro (for part)
Stopping position	various	SBB-P, SR40	Distance measurements at stations
Energy data	various	SBB-I-EN	
Data evaluation, analysis	Xiaolu Rao	SR40	

Table 4 Test team roles

2.5. Raw data recorded

The figure below provides an overview of the raw data recorded. It shows the location where the raw data for the analyses in this report was collected.

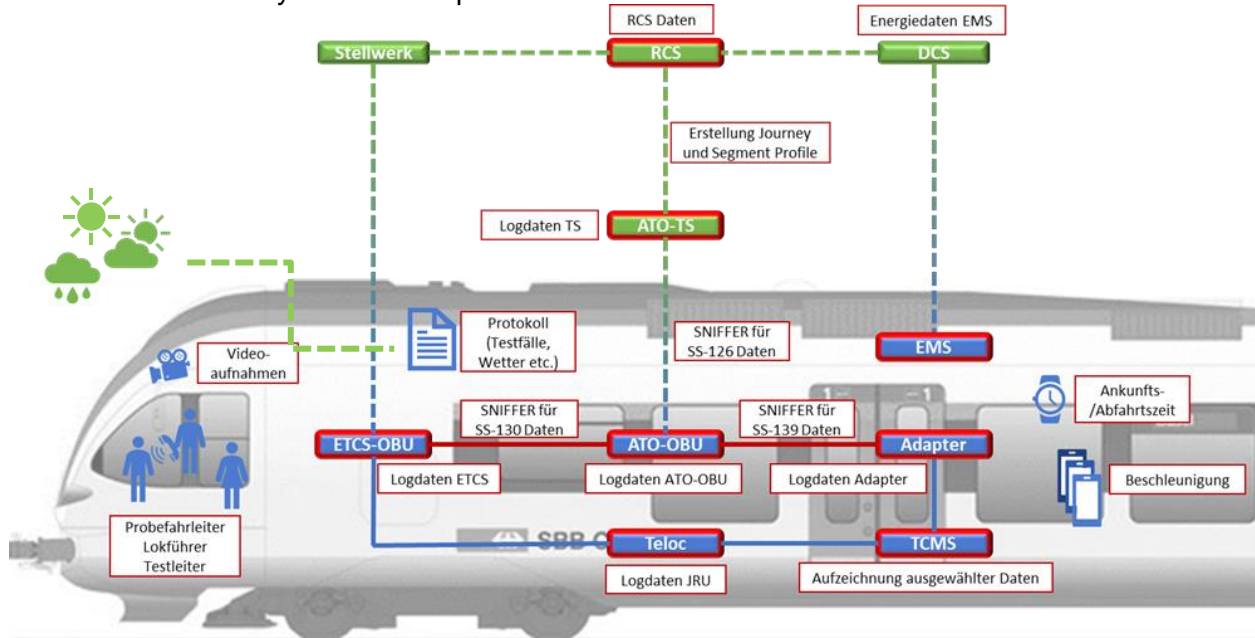

Figure 4 The data which was collected

Some data, such as arrival times and stopping accuracy, was recorded manually. Similarly, the log data of the systems involved was stored. Activity at the interfaces was continuously logged by means of a sniffer that was looped into the Ethernet connection. The video recordings were made using a camera on the driver's console. They were made in case it was necessary to reproduce occurrences on the route and in the driver's cab; they have since been deleted.

2.6. Test cases

To ensure that it was feasible to conduct the DB Cargo pilot on this line, the DB Cargo test programme was worked through, insofar as it was possible to do so with a passenger train multiple unit. Since the ARCC consortium's test documentation has not been released for publication, a detailed description is not given in this document.

In order to generate as much additional benefit as possible for smartrail 4.0, extensive data recordings were made during the validation runs and these were archived for future use.

2 test weekends, each of 2 days, were scheduled for the test cases to prepare the route for the DB Cargo pilot. This preparatory work was successfully completed during the second test weekend. The few remaining train paths were used to make comparisons between manual and automated (ATO) runs.

3. Commissioning

The ATO OBU had been commissioned as part of ATO2Basic (See Reference 2); it was not re-commissioned for the runs on this line.

Commissioning in the sense of preparing the line for the DB Cargo test runs was carried out by running along the entire line several times in both directions. No adjusting or calibrating the ATO OBU was necessary.

The result was that, after transferring the segment and journey profiles according to the draft TSI 2022 standards, the entire route could be traversed in both directions in ATO mode without an ATO Disengaging event occurring. This confirmed the correctness of the segment profiles, with the result that the ATO GoA2 Freight Demonstrator test runs could start.

As an additional finding from these runs, it can be stated that the functional ATO OBU model is interoperable to the extent that ATO GoA2, if provided with segment profiles according to the draft standard, functions on different lines without requiring any re-calibration.

4. Observations

All our observations were made during the validation test runs on 18/19 July and 25/26 July 2020.

In addition, as much comparative data as possible was collected during the test runs, in some cases also in relation to the test runs already carried out on the Lausanne - Villeneuve line, in order to confirm the completeness of the verification.

During the test runs on the first weekend, unexpected behaviour was observed. When analysed together with the supplier, first an operating error was identified, and then a programming error in SBB-P's SS139 adapter was also discovered. The latter was immediately rectified.

To ensure that the first weekend's test results were still valid once these two points had been rectified, a second test weekend had to be scheduled.

4.1. Preparing the line for the DB Cargo test runs

4.1.1. Verifying the ATO project plans (segment profiles)

Several runs were made along the line in both directions entirely under GoA2 control.

- The ATO OBU never reached a condition which required the locomotive crew to take over.
- The train arrived exactly on time at the precise stopping positions.

This showed that the segment and journey profiles produced by SBB in accordance with the SS125/126 draft standards were correct. This should be seen in connection with the subset versions agreed with the supplier Siemens.

Trains can be operated under ATO GoA2 control in accordance with the draft TSI standards on the Châteauneuf-Conthey-Sion-Sierre line completely trouble-free and with the performance characteristics already applied on the Lausanne-Villeneuve line.

4.1.2. Test preparation for DB Cargo

The test cases, which had been minimally adapted for runs with the FLIRT, were then performed – with the exception of test cases specifically applicable to freight traffic which could not be carried out.

Since the test cases have not yet been published by the ARCC consortium, they cannot be shown here in any detail. These are due to become available when ARCC project is published in 2021. However, our observations of the driving performance are described in the sections below.

- All the adapted test cases were run successfully.
- The Châteauneuf-Conthey-Sion-Sierre line is therefore deemed suitable for the planned DB Cargo test runs.

4.2. Basic driving performance

4.2.1. Punctuality / arrival time

During the verification runs, it was observed that the difference between the actual and scheduled arrival time was also a matter of just a few seconds on the Sion-Sierre line. This is consistent with the observations made on the Lausanne-Villeneuve line (see Reference 2: ATO2Basic-Phase 2-Phasenabschlussbericht [end-of-phase report])

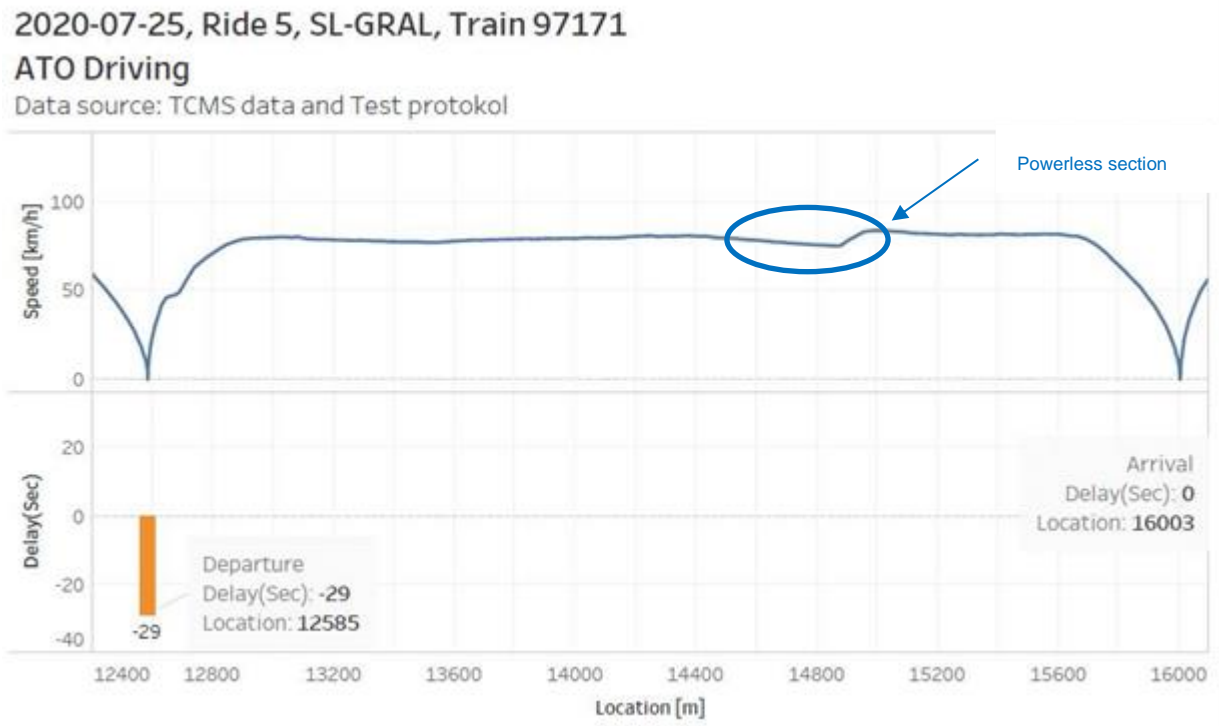

Figure 5 Time difference from the scheduled arrival time

In this example, the stopping position was reached at the precise second. The "ATO-Start" button had been pressed 29 seconds before the scheduled departure time. It is obvious that, in this instance, the ATO OBU was able to take advantage of a time reserve specified in the timetable and that it did not run at the maximum line speed of 160 km/h on this section.

This section of the line includes a powerless section, marked as such in the figure. It can be seen that the speed reduces slightly at this point because the train was not running under traction. At the end of the powerless section, the ATO OBU accelerates again to ensure that the train arrives on time to the very second.

4.2.2. Stopping position

In order to verify the accuracy of the stopping position, the variation between stopping positions was recorded. To do this, the position of the leading edge of the first door's retractable bridge plate was marked on the platform during the first ATO run; the differences from this mark were measured during the subsequent runs.

4.2.2.1. Analysing the stopping positions

The stopping positions were analysed in the same way as on the Lausanne-Villeneuve line (see Reference 2: ATO2Basic-Phase 2- Phasenabschlussbericht [end-of-phase report]). The y-axis in Figure 6 below shows in percentages how frequently the trains stopped within the tolerance range in metres shown on the x-axis.

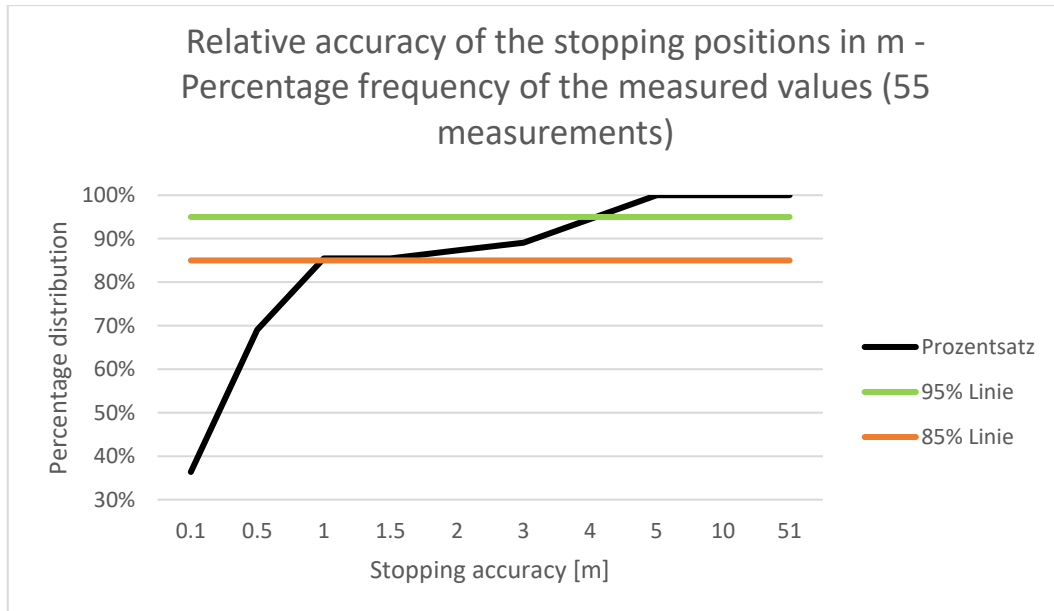

Figure 6 Analysis of the accuracy of the stopping procedures

As on the Lausanne-Villeneuve line, the measurements made on the Sion-Sierre line also show **100%** compliance with the specifications for regional services in the training documents, and **85%** compliance with what smartrail 4.0 specifies ($< \pm 1.5\text{m}$). No analysis was undertaken of the distance between the balise positions and the stopping positions.

4.2.2.2. The stopping position's dependence on the balise's position

No detailed analysis was undertaken on the extent to which the accuracy of the stopping position depended on the distance from the balise. However, our observations during the validation test runs established that the greater the distance from the last balise, the less accurate the stopping position.

On both the Sion-Sierre and the Lausanne-Villeneuve lines, the percentage of measurements that comply with the smartrail 4.0 specifications of $\pm 1.5\text{m}$ was the same, assuming all measurements on the Lausanne-Villeneuve line are used as the basis for comparison. (See reference 2).

Assuming that the same project planning rules as regards the positioning of the ETCS balises applied to both lines, then the figure of 85% compliance with the SR40 specifications is plausible.

4.3. Further consideration of driving performance / additional parameters

On the Châteauneuf-Conthey-Sion-Sierre section, the ATO OBU's driving performance was essentially the same as on the Lausanne-Villeneuve line.

However, the distance between the stopping positions was greater and the maximum speed was higher. This meant that on some sections of the line, the ATO OBU drove at the maximum speed set on the ETCS DMI of 130 km/h; this did not happen on the Lausanne-Villeneuve line. The implications of this are described in the following sections.

The locomotive crew noted that in some cases the ATO OBU (functional model) reduced speed on negative gradients by decelerating rather than by coasting. Nevertheless, the train arrived at the subsequent stopping position at exactly the precise second.

Phase 3 of the ATO2Basic project should investigate the extent to which there is still potential for optimising this aspect of how the ATO OBU exercises control.

4.3.1. Reducing delays

The essential feature of ATO GoA2, i.e. to reduce delays, has already been discussed in Section 4.2.1.

The timetable specification or the RCS forecast is based on the maximum speed of 160 km/h which applies to longer sections of line. However, due to the characteristics of the test installation, a vehicle-specific maximum speed of 130 km/h was specified for the ETCS for the test runs.

4.3.2. Driving at the braking curve

As on the Lausanne-Villeneuve line, ATO also drove (at critical times) towards the end of the MA very close to the braking curve. The knowledge gained from our experience of ATO2Basic was fully confirmed. Figure 7 below compares the difference between the ATO and the locomotive crew's driving profiles on the Ardon-Sion-Sierre line.

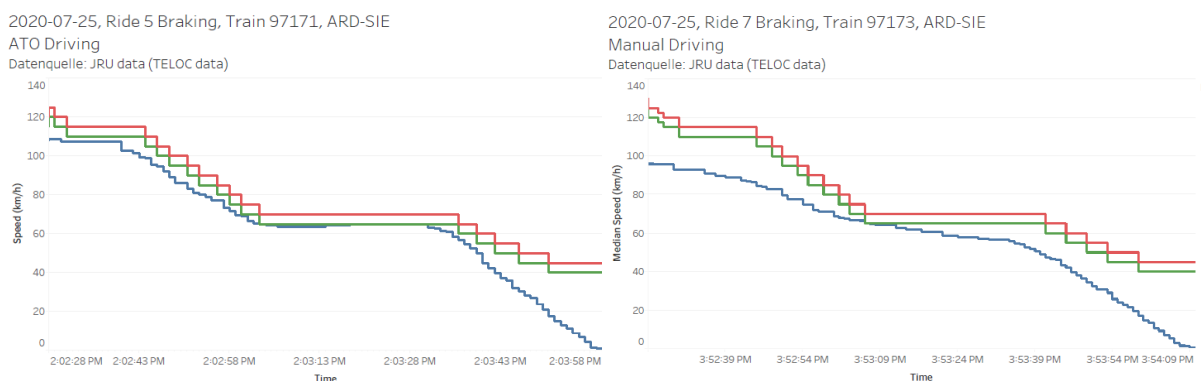

Figure 7 Driving close to the braking curve

Red:	Most Restrictive Speed Profile (MRSP)
Green:	ETCS permitted speed
Blue:	Train speed (ATO or manual)

4.3.3. Energy consumption

Industry identified an energy saving potential of up to **42%** on regional services (see Reference 1). Non-representative, simple comparative runs between ATO and the locomotive crew were used to determine whether this statement regarding energy savings might already be true with the currently available ATO OBU. As illustrated below (Figure 8), ATO's energy saving potential was observed to be **37%**.

The energy consumption data was extracted from the Energy Measurement System (EMS) via the Data Collection System (DCS). The data shows the total electrical energy consumed by the vehicle. Regenerated energy is included as negative values (energy production). The average consumption by auxiliary equipment, such as air conditioning, was excluded from the analysis; consequently, the values shown below represent a good approximation to energy consumption resulting from traction and recuperation.

Figure 8 below shows a direct comparison between manual driving and ATO driving on the same Granges-Lens - Sierre section of line. The graph shows the electric brake's energy consumption and recuperation. The use of the pneumatic brake is not shown in this graph, but it was included in the energy consumption calculation.

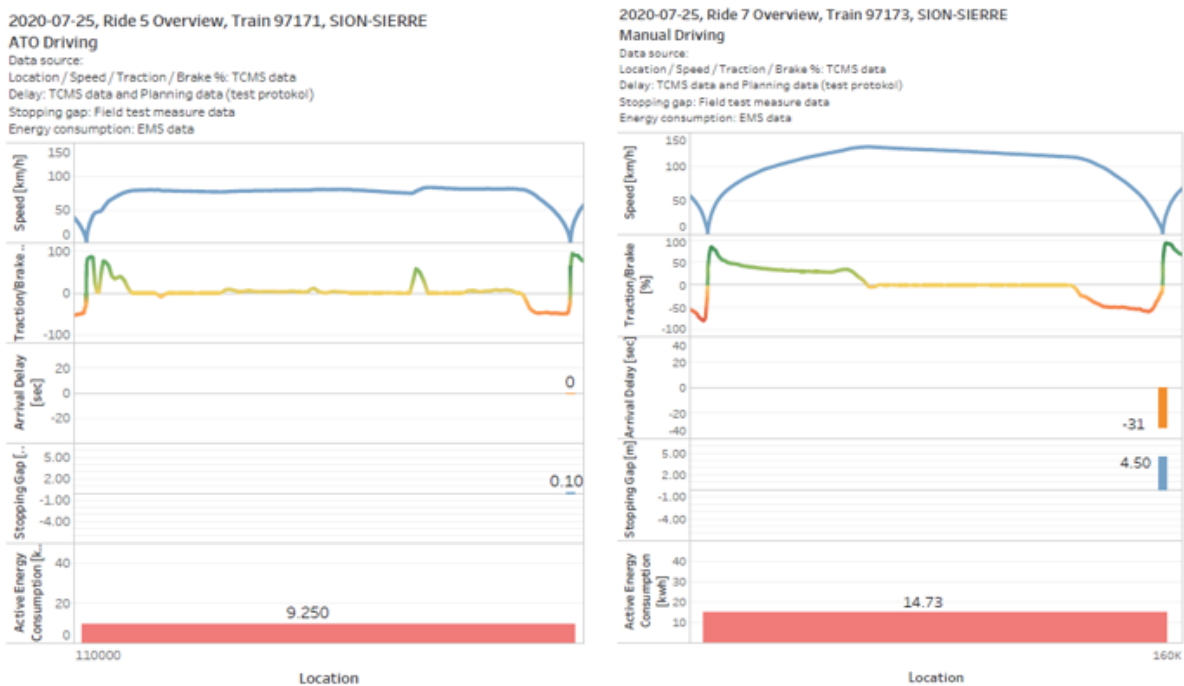

Figure 8 Comparison of energy consumption, driving profile and stopping accuracy

The differences between the driving profiles and punctuality on the 3.4 km section of line (SL-GRAL) can be seen very clearly.

4.3.4. Dynamic driving/braking performance during the test runs

Acceleration measurements were used in an attempt to analyse the extent to which the dynamic driving/braking performance under ATO and manual driving might affect passenger comfort.

There is neither a clear definition nor an established method of measuring actual passenger comfort. Specifications, e.g. those taken from procurement documents, cannot be used for this purpose.

It was assumed that passenger comfort is related to accelerations occurring in 3 dimensions; an attempt was made, therefore, to derive an interpretation from the values measured.

This was done by recording the raw data (from accelerometers in the X, Y and Z axes) on several mobile phones using the 'phyphox' application (app). However, it was not possible to interpret the data conclusively.

Consequently, it was decided not to produce an analysis based on the acceleration values recorded. Details of the measurements and of the attempts to interpret the data are shown purely for information purposes at Annex 1 .

The impression gained during the test drives was that starting, stopping and driving across points was smoother with manual driving than with ATO driving. This may be ascribed to the fact that the locomotive crew, unlike the ATO OBU, did not drive across points at the maximum speed permitted on that section of line.

4.3.5. Driving performance on powerless sections

On the Sion-Sierre line, it was observed that the ATO OBU performed correctly when driving through powerless sections. On entering the powerless section, ATO set the tractive force to 0. Only after passing through the powerless section was a value unequal to 0 applied again.

As a general rule, the locomotive crew switched the main switch on and off shortly beforehand so that the main switch was already open as the train entered the powerless section. However, the ATO OBU only reduced the tractive force as the train entered the powerless section; this is too late in practice. This ATO functionality needs to be investigated in detail as regards its neutral section function under BL 2.3.0d and, in particular, under BL3. At the very least, there is still some potential for optimisation here.

In addition, the following experiment was carried out: A stopping point was inserted into a simulated powerless section defined in the segment profile. The ATO OBU correctly interpreted both the stopping point and the powerless section. It stopped within the neutral section. However, it could no longer continue the journey after this point because the tractive force was specified as "Zero" on the powerless section. This behaviour gives rise to potential for errors when planning an ATO route. The phenomenon has already been reported back to the Shift2Rail standardisation committees.

4.4. Outlook

As far as SBB is concerned, no further validation or other test runs are needed as part of the Shift2Rail/DB Cargo ATO GoA2 Freight Demonstrator.

5. Conclusion

- The ATO project plans and the segment profiles produced for the ATO test runs on the Sion-Sierre line have been validated and can be used for the ATO GoA2 Cargo Demonstrator.
- DB Cargo has meanwhile carried out the test runs with a freight train and no problems with the ATO project plans (segment profiles) were encountered.
- An ATO OBU can be operated on any line
- One observation in connection with neutral sections (see Section 4.3.5) was reported back to the standardisation committees.
- All the observations made during the test runs on the Lausanne-Villeneuve line as part of ATO2Basic were corroborated:
 - Observations regarding driving at the braking curve
 - Punctuality plus stopping precisely at the stopping point
 - The energy saving potential identified by the industry (see Reference 1) seems plausible. In comparison, one separate measurement showed an energy saving of **37%**.
- Observations that may require further analysis and that may contain potential for optimising the ATO OBU were discussed with the supplier (Siemens). However, these do not form part of this document.

6. Reference documents

1. Presentation ATO/DAS over ETCS - The way towards unattended operation for Main Lines - Alstom, Feb. 2017
2. ATO2Basic-Phase 2- Phasenabschlussbericht [end-of-phase report] V1.0
3. [The ARCC's project page on the Shift2Rail website](#)

Annex 1 – Acceleration measurements

This Annex is purely informative, and for the reasons described in Section 4.3.4 was not included in the analyses which form part of this report.

For measuring the acceleration values, the raw data (accelerometers in X-Y and Z axes) were recorded on several mobile phones using the 'phyphox' application (app).

After extracting the recorded data, an analysis was carried out to determine whether the recordings appeared random or whether patterns were discernible. However, it was not possible to arrive at a conclusive interpretation.

For this reason, it was decided not to produce an analysis of passenger comfort based on the acceleration values recorded.

The following procedure was applied: the recorded acceleration measurements were first smoothed; the change in acceleration ('jerk') was then derived.

Jerk (acceleration change) and change in jerk is defined as:

*"Jerk is a term used in kinematics. It is the instantaneous change in the rate of acceleration of a body. In formal terms, jerk is the derivative of acceleration with respect to time. (...) In physics, jerk or jolt is the rate at which an object's acceleration changes with respect to time."*¹

The following figures show individual measurements of the acceleration values and their derivatives.

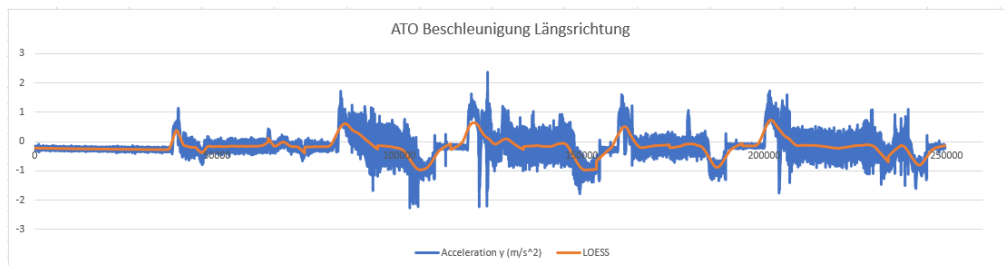

Figure 9 Example of a smoothed measurement curve

¹ [https://en.wikipedia.org/wiki/Jerk_\(physics\)](https://en.wikipedia.org/wiki/Jerk_(physics)) downloaded on 5.1.2021

Comparison of Runs 5 and 7 in the first CHF-SIO section in the transverse direction

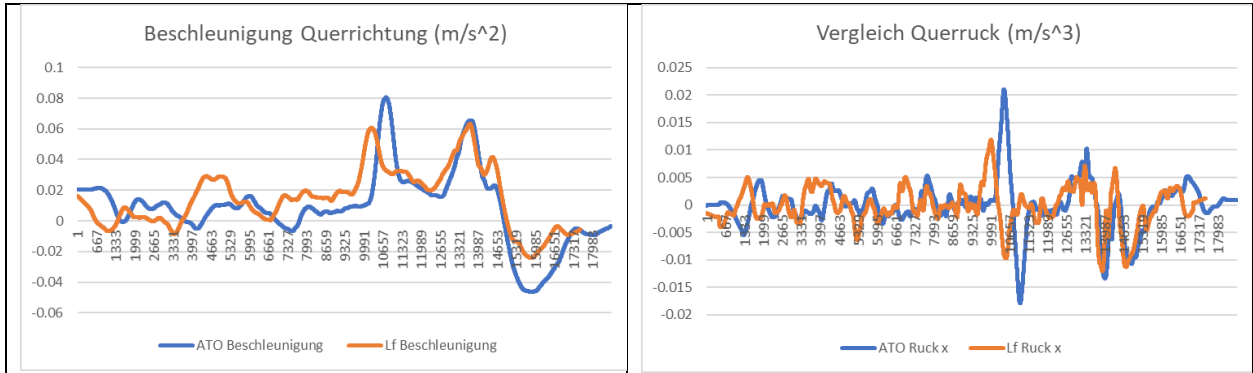

Figure 10 Transverse direction

Comparisons of Runs 5 and 7 in the SL-GRAL section in the longitudinal direction

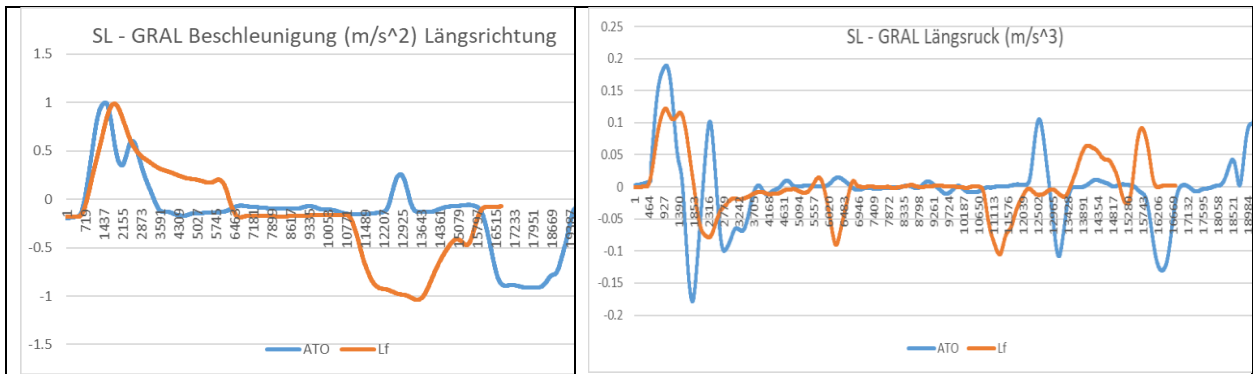

Figure 11 Longitudinal direction

Comparisons of the jerk change

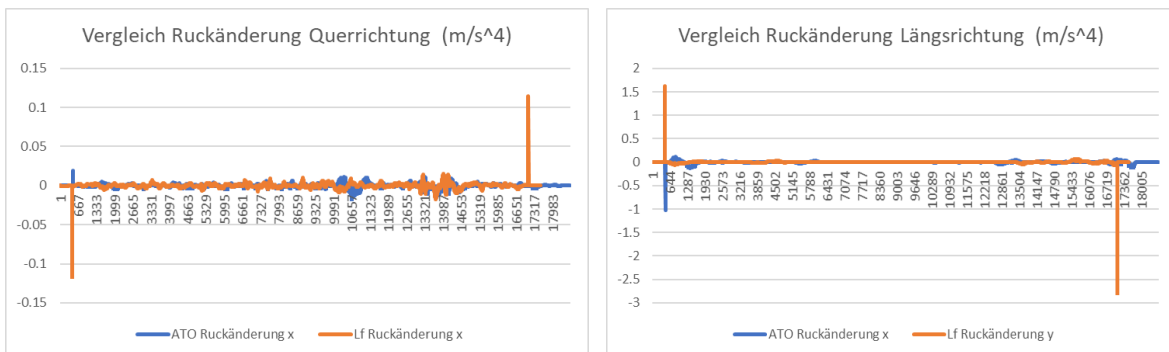

Figure 12 Comparison of jerk change in transverse and longitudinal directions

The change in jerk is the second derivative of acceleration with respect to time.